

HANERSUN

Wall Mounted Lithium Battery Series Installation Manual

2023 Edition



V-2.0



CONTENTS

1. Safety Information	2
1.1. General Safety	2
1.2. Personal Safety	2
1.3. Electrical Safety	3
1.4. Transportation Safety	6
2. Product Information	6
2.1. Battery Overview	6
2.2. Appearance	7
2.3. Front Panel	7
2.4. Dimensions	11
2.5. Capacity Options	12
2.6. Parallel Communication	13
2.7. Recommended Settings	13
3. Attentions	14
4. Specifications	14

Thank you for choosing HANERSUN storage products!
非常感谢您选用汉伏能源储能产品！



1. Safety Information

1.1. General Safety

Please carefully read the manual safety precautions, and observe all the safety instructions on the equipment and in this document.

The "DANGER" , "WARNING", and "NOTICE" statements in this document do not cover all the safety instructions. They are only supplements to the safety instructions.

For user safety and utilization efficiency of this manual, a list of symbols are designed to alert people from danger. You must understand and comply with the emphasized information to avoid personal injury and property damage. Relative safety symbols have been listed below.

 Danger	DANGER indicates a hazardous situation which, if not avoided will result in serious injury and fire.
 Warning	WARNING indicates a hazardous situation which, if not avoided will result in property loss or void warranty.
 Notice	NOTICE indicates normal situation which, if not avoided will result in that battery doesn't work.

Follow local laws and regulations when installing, operating, or maintaining the equipment. The safety instructions in this document are only supplements to local laws and regulations.

1.2. Personal Safety

Personal Requirements

People who plan to install or maintain battery equipment must be trained, understood all necessary safety precautions, and are able to perform all operations correctly.

Only qualified professionals or trained people are allowed to install, operate, and maintain the equipment.

Personal Safety









- Do not place battery at a children or pet touchable area.
- Do not touch the energized battery, as the enclosure is hot.
- Do not touch the energized battery terminals.
- Do not stand on, lean on, or sit on the battery.

1.3. Electrical Safety

Symbols on Battery

There are some electrical symbols on battery relate to electrical safety. Please make sure you have fully understand them before installation.

	Electrical danger	Voltage exists when the battery is powered on. Only qualified engineers are allowed to operate.
	Earth connector	Earth connection.
	DC positive and negative connectors	Identify positive and negative connectors of DC power source.
	CE mark	The product meets CE certification.
	WEEE tag	Can't leave battery as garbage disposal.
	Recycle	Battery can be recycled.

Electrical Safety



- Before installation, ensure that the equipment is intact. Otherwise, electric shocks or fire may occur.

- Do not connect or disconnect power cables when battery is power-on. Which may cause electric arcs and sparks more overfire or personal injury. Before connecting a power cable, check the positive or negative connectors are correct.
- Batteries are not allowed in series.
- Different batteries should not be connected in parallel.
- Do not connect battery with AC directly.
- Do not connect battery with PV wiring directly.
- Do not connect battery to faulty or unqualified inverter or charger.
- Do not create short circuits with the external connection.
- Make sure the grid is cut off and the battery is powered off before maintenance.
- Make sure the earth cable is connected correctly before operation.

 **Warning**

- Recharge battery in every six months.
- Recharge battery within 10 days after battery is fully discharged.
- Please engage greater than or equal to two batteries when maximum charge current is more than 70A.
- Make sure battery cable placement is installed correctly.
- When the battery is being installed or repaired, make sure the battery is powered off and using a multimeter to make sure there is no voltage in the positive and negative terminals.

 **Notice**

- Please use dedicated insulated tools for install and maintenance.
- Please make sure all batteries are power-off when multiple parallel connection.
- Please check lights on sequence when battery power-on.
- Please make sure communication connection connect correctly with battery and inverter.
- Please make sure ADDS dip switch settings are correctly for single or multiple batteries.
- Please check inverter alarm or SOC reading when there is BMS communicated with inverter.

Environment Safety



- Ensure that the equipment is installed in a dry and well-ventilated environment.
- The installation position must be away from direct sunlight and rain.
- The installation position must be far away from fire sources.
- The installation position must be far away from water sources such as taps, sewer pipes, and sprinklers to prevent water seepage.
- The bracket must be installed solidly and horizontally.
- Do not expose the equipment to flammable or explosive gas or smoke.
- Do not perform any operation on the equipment in such environments.
- The operation and service life of the battery depends on the operating temperature. Operate the battery at a temperature equal to or better than the ambient temperature. The recommended operating temperature range is from 0°C to 30°C.

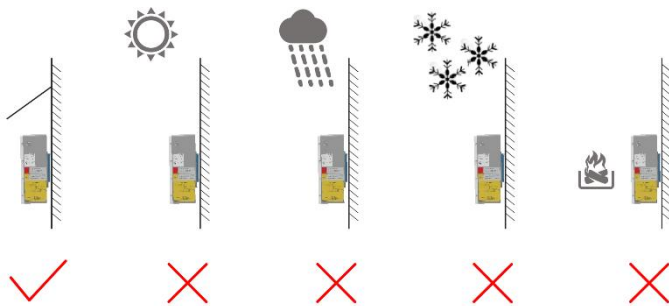

1.4. Transportation Safety



- The products passed certification UN38.3.
- The products have MSDS.
- The products belong to class 9 dangerous goods.
- Please protect the packing case from the below situations.
- Being dampened by rains, snows, or falling into water.
- Falling or mechanical impact.
- Being upside-down or tilted.

2. Product Information

2.1. Battery Overview

The battery is a wall mounted lithium battery pack which consists of long span LiFePO4 battery cells and functional BMS. It can store and release electric energy based on the requirements of the inverter controller. It is mainly for home energy storage system.

Features

- LiFePO4 prismatic cell
- 6000 cycles @0.5C conditions
- Maximum 0.4C charge and 0.7C discharge capability
- Wall mounted IP 65 grade
- Be extended to 8 packs maximum
- Protective and active BMS allows greater reliability and control
- Building in terminal design
- Fully recyclable at the end of life
- Compact

2.2. Appearance



2.3. Front Panel

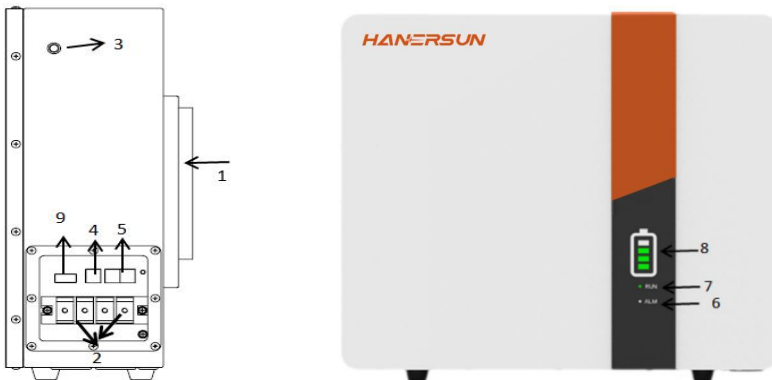

(1). Wall mount

Please mount bracket on the wall by six M8 bolts firstly. Then lift battery and stuck with bracket.

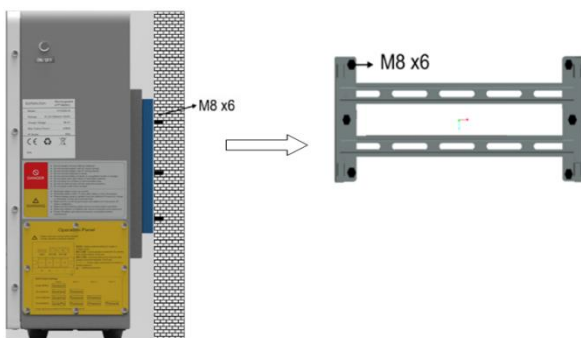

(2). Wiring block

2P(1P positive and 1P negative) power interface, printed by "+", "-", front-mounted wiring method, positive and negative terminals are insulated by thermoplastic polyester (PBT) insulating sheets.

(3). Switch

BMS switch, when it is turned off, the BMS can be put to sleep and the charge and discharge MOS transistors will be turned off at the same time; normal operation will be restored after it is turned on.

Note: Please do not turn on the system switch when the product is not in use to avoid self-consuming the lithium battery.

Version 1 : CAN2.0B/RS485

(4). CAN2.0B COMM to inverter

BMS has battery pack upload CAN communicate function, Baud Rate 500K. CAN communicate interface adopt 8P8C network cable interface. CAN communicate with the inverter or CAN TEST through the CAN interface. When the battery string is connected, RS485 communication is used to connect the battery string. Finally, the data, status and information of the battery string are uploaded to the PCS through CAN communication.

CAN and RS485 communication interface definition:

Pins	Definition
1、 8	RS485-B
2、 7	RS485-A
4	CAN-H
5	CAN-L
3、 6	GND

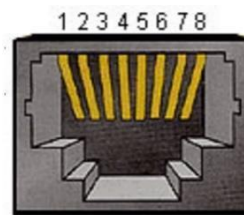

(5). RS485 COMM to parallel battery

The BMS has RS485 communication for multiple battery pack collections, and the baud rate is 19200bps. RS485 communication interface adopts 8P8C network cable interface.

RS485 pin interface definition (RJ45-8P8C)

Pins	Definitions
1、 8	RS485-B
2、 7	RS485-A
3、 6	GND
4、 5	NC

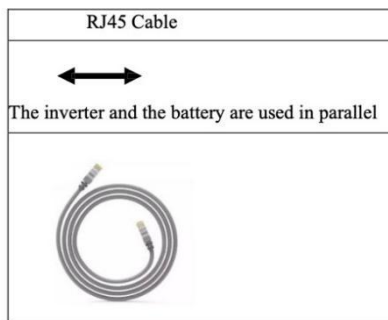
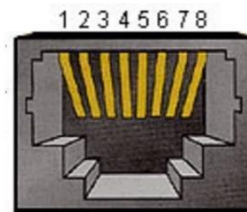

(6). LED indicators

System	Status	RUN	ALM	SOC				Definition
		●	●	●	●	●	●	
switch on	sleeping	off	off	off	off	off	off	All off
standby	normal	on	off	SOC indicators				standby
Charging	normal	on	off	SOC indicators				Flashing
	OC ALM	on	Flashing	SOC indicators				Flashing
	OV ALM	on	off	SOC indicators				
	OT ALM	on	Flashing	SOC indicators				
Discharging	normal	Flashing	off	SOC indicators				SOC indicators
	alarm	Flashing	Flashing					
	All Pro- tections	off	on	off	off	off	off	Fully discharged or 48 hours no instructions, going into sleep mode
	UV Pro- tections	off	off	off	off	off	off	Stop discharging

(7). Red alarm indicator, normally off. And always on under fault conditions with beep.

(8). SOC indicator, four green LED lights to display the real-time SOC capacity of the lithium battery pack.

Status	charge				discharge			
SOC	L4●	L3●	L2●	L1●	L4●	L3●	L2●	L1●
0~25%	off	off	off	flashing	off	off	off	on
25~50%	off	off	flashing	on	off	off	on	on
50~75%	off	flashing	on	on	off	on	on	on
≥75%	flashing	on	on	on	on	on	on	on
RUN ●	on				flashing			

(9). DIP

Switches

Parallel DIP switch definition: For multi-battery communication when the battery packs are connected in parallel, use the DIP switch to distinguish different pack addresses, and the hardware address can be set by the DIP switch on the panel below.

51B02T

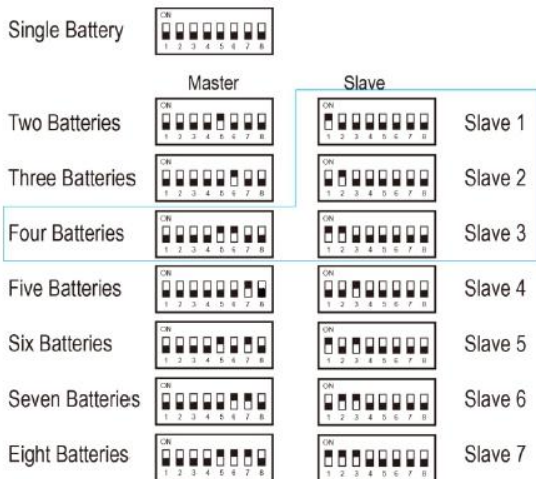
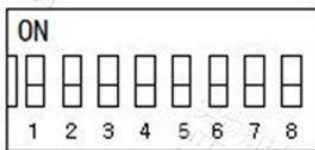

For Example, blue frame is the settings for 4 batteries.

2.4 . Dimensions

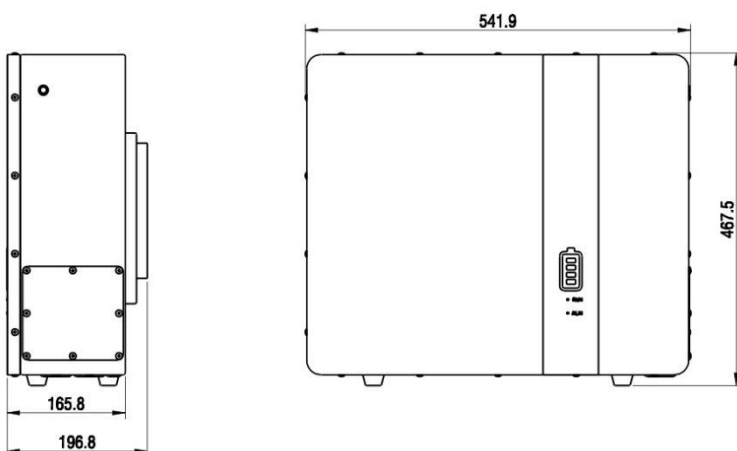

2.5. Capacity Options

The battery can be parallely connected for extending power(kW) and energy(kWh).



- The maximum power(kW) is limited by main cables from master battery to inverter.
- The maximum 8 battery packs can be parallely communicated.

For example, ONE PACK is 5.12kWh

5.12kWh



10.44kWh



20.88kWh



AND MORE

2.6. Parallel Communication

When multiple packs are connected in parallel, the RS485 interface is used as the parallel communication interface. The master pack can read the sum of the slave battery data of all parallel packs through the RS485 communication.

Two packs RS485 parallel connection 1 :

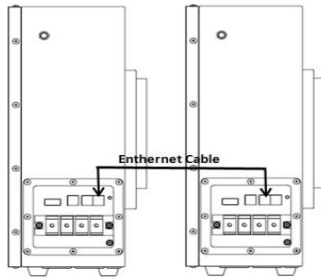

More than two packs RS485 parallel connection 2 :

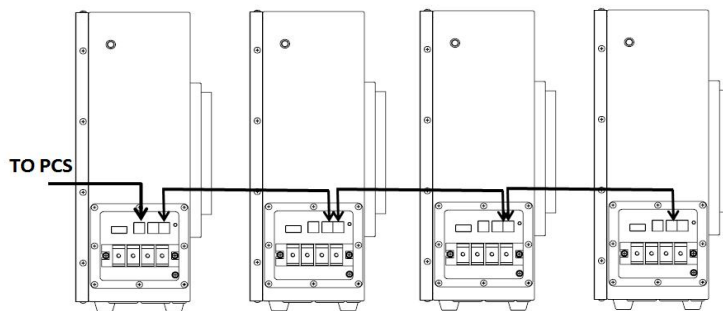

2.7. Recommended Settings

Lithium battery pack is not as the same as lead-acid battery, therefore the devices which you connect with the battery pack for charging and discharging, such as inverters, MPPT charger controllers or UPS, please implement pre-settings as recommended settings as below before start.

Setting	5120Wh
Max. Charging Voltage	57V
Max. Charging Current	40A (N=1) 40A*N (N≥2)
Max. Discharging Current	75A*N
Cut-off Voltage	45V

Notes: "N" means the number of battery packs connected in parallel.

3. Attentions

- Before using the battery pack, please read the manual carefully to understand the usage and precautions;
- Non-professionals shall not disassemble the battery without authorization;
- Be sure to use the original special charger for charging or the charger agreed by both parties;
- During use or storage, if you find abnormal heating, discoloration, deformation or other abnormalities in the battery, please stop using the battery;
- The storage temperature of the battery is -20~35°C, please place the battery in a dry and cool environment.
- Do not bump, apply external force or make the battery fall from high altitude during use;
- If the battery is not used for a long time, the battery pack needs to be charged to more than 80%, turn off the power switch, and store it in a ventilated and dry environment.

4. Specifications

Nominal Capacity	5.12kWh
Voltage	51.2V
Charge Voltage	57V
Discharge Voltage Range	45-57V
Max. Charging Current	45A
Max. Discharging Current	75A
Max. Output Power	3840W
DOD	90%

Modules Connection	1-8 in parallel
Communication	CAN OR RS485
Cycle Life	≥6000 25°C 0.5C
Working Temp. Range	Charge: 0°C~+55°C,
	Discharge: -10°C~+55°C
Storage Temperature(°C)	-20°C~+35°C
Net Weight (kg)	48.5kg
Gross Weight (kg)	52.5kg
Product Dimension (mm)	536.3*464*180.5mm
Package Dimension (mm)	592*522*252mm



Hanersun ESS Solution Co., Ltd

 10F, Building B4, No.19, Suyuan Avenue, Jiangning District, Nanjing, China

 211100

 +86-25-5279-1766

 sales@hanersun.com

 www.hanersun.com/contact-us